

Silicon PIN Photodiode

Description

BPW24R is a high sensitive silicon planar photodiode in a standard TO-18 hermetically sealed metal case with a glass lens.

A precise alignment of the chip gives a good coincidence of mechanical and optical axes. The device features a low capacitance and high speed even at low supply voltages.

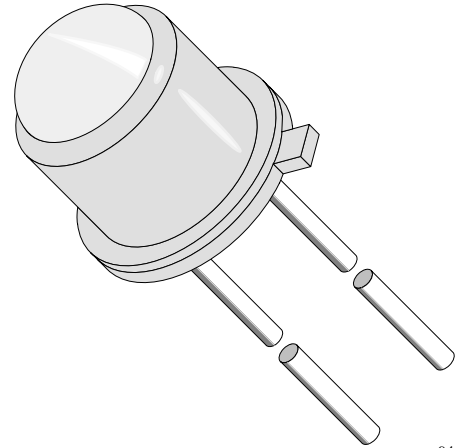

94 8642

Features

- Hermetically sealed TO-18 case
- Exact central chip alignment
- Cathode connected to case
- Angle of half sensitivity $\varphi = \pm 12^\circ$
- Extra fast response times at low operating voltages
- High photo sensitivity
- Radiant sensitive area $A=0.78 \text{ mm}^2$
- Suitable for visible and near infrared radiation
- For photodiode and photovoltaic cell operation

Applications

High speed photo detector

Absolute Maximum Ratings

$T_{\text{amb}} = 25^\circ\text{C}$

Parameter	Test Conditions	Symbol	Value	Unit
Reverse Voltage		V_R	60	V
Power Dissipation	$T_{\text{amb}} \leq 25^\circ\text{C}$	P_V	210	mW
Junction Temperature		T_j	125	$^\circ\text{C}$
Operating Temperature Range		T_{amb}	-55...+125	$^\circ\text{C}$
Storage Temperature Range		T_{stg}	-55...+125	$^\circ\text{C}$
Soldering Temperature	$t \leq 5 \text{ s}$	T_{sd}	260	$^\circ\text{C}$
Thermal Resistance Junction/Ambient		R_{thJA}	350	K/W

Basic Characteristics

$T_{amb} = 25^{\circ}\text{C}$

Parameter	Test Conditions	Symbol	Min	Typ	Max	Unit
Breakdown Voltage	$I_R = 100 \mu\text{A}, E = 0$	$V_{(BR)}$	60	200		V
Reverse Dark Current	$V_R = 50 \text{ V}, E = 0$	I_{ro}		2	10	nA
Diode Capacitance	$V_R = 0 \text{ V}, f = 1 \text{ MHz}, E = 0$	C_D		11		pF
	$V_R = 5 \text{ V}, f = 1 \text{ MHz}, E = 0$	C_D		3.8		pF
	$V_R = 20 \text{ V}, f = 1 \text{ MHz}, E = 0$	C_D		2.5		pF
Open Circuit Voltage	$E_e = 1 \text{ mW/cm}^2, \lambda = 950 \text{ nm}$	V_o		450		mV
Temp. Coefficient of V_o	$E_e = 1 \text{ mW/cm}^2, \lambda = 950 \text{ nm}$	TK_{V_o}		-2		mV/K
Short Circuit Current	$E_e = 1 \text{ mW/cm}^2, \lambda = 950 \text{ nm}$	I_k		55		μA
Temp. Coefficient of I_k	$E_A = 1 \text{ klx}$	TK_{I_k}		0.1		%/K
Reverse Light Current	$E_e = 1 \text{ mW/cm}^2, \lambda = 950 \text{ nm}, V_R = 20 \text{ V}$	I_{ra}	45	60		μA
Absolute Spectral Sensitivity	$V_R = 5 \text{ V}, \lambda = 870 \text{ nm}$	$s(\lambda)$		0.60		A/W
	$V_R = 5 \text{ V}, \lambda = 900 \text{ nm}$	$s(\lambda)$		0.55		A/W
Angle of Half Sensitivity		ϕ		± 12		deg
Wavelength of Peak Sensitivity		λ_p		900		nm
Range of Spectral Bandwidth		$\lambda_{0.5}$		600...1050		nm
Rise Time	$V_R = 20 \text{ V}, R_L = 50 \Omega, \lambda = 820 \text{ nm}$	t_r		7		ns
Fall Time	$V_R = 20 \text{ V}, R_L = 50 \Omega, \lambda = 820 \text{ nm}$	t_f		7		ns

Typical Characteristics ($T_{amb} = 25^{\circ}\text{C}$ unless otherwise specified)

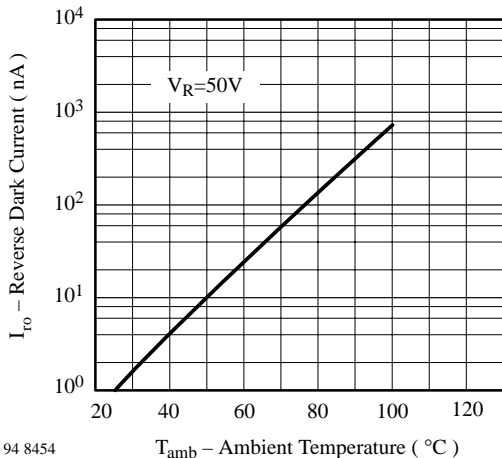

Figure 1. Reverse Dark Current vs. Ambient Temperature

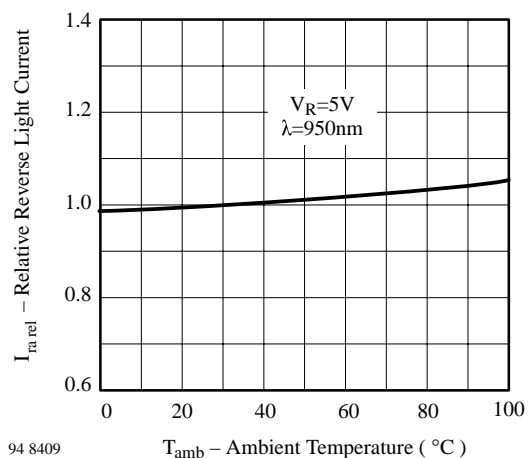

Figure 2. Relative Reverse Light Current vs. Ambient Temperature

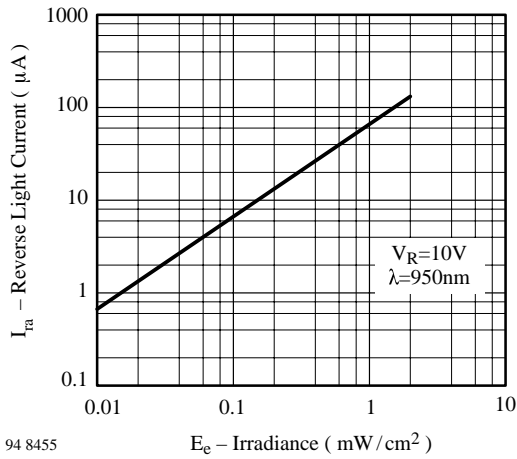

Figure 3. Reverse Light Current vs. Irradiance

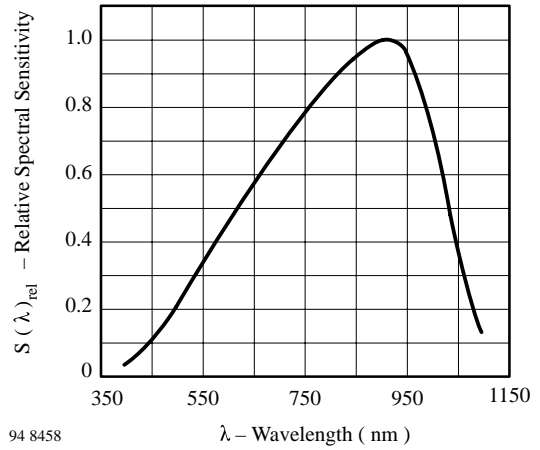

Figure 6. Relative Spectral Sensitivity vs. Wavelength

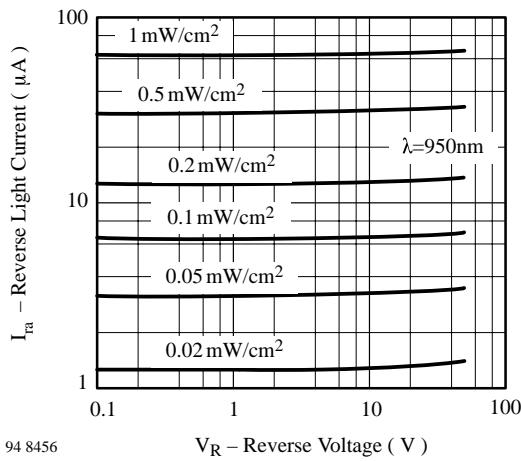

Figure 4. Reverse Light Current vs. Reverse Voltage

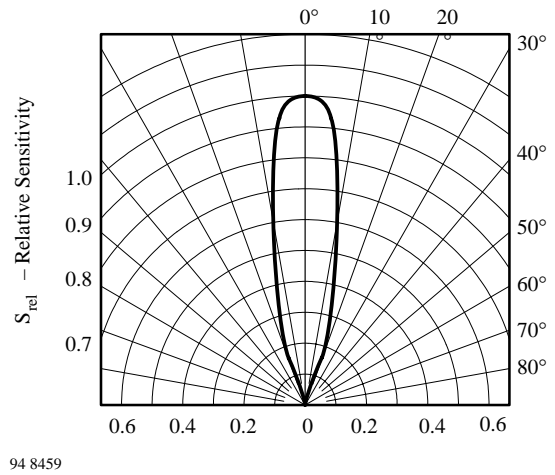

Figure 7. Relative Radiant Sensitivity vs. Angular Displacement

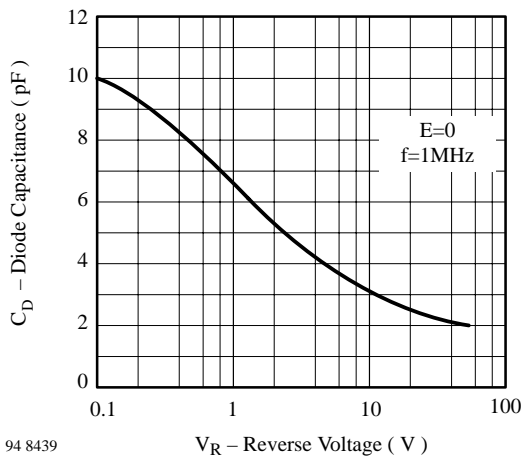
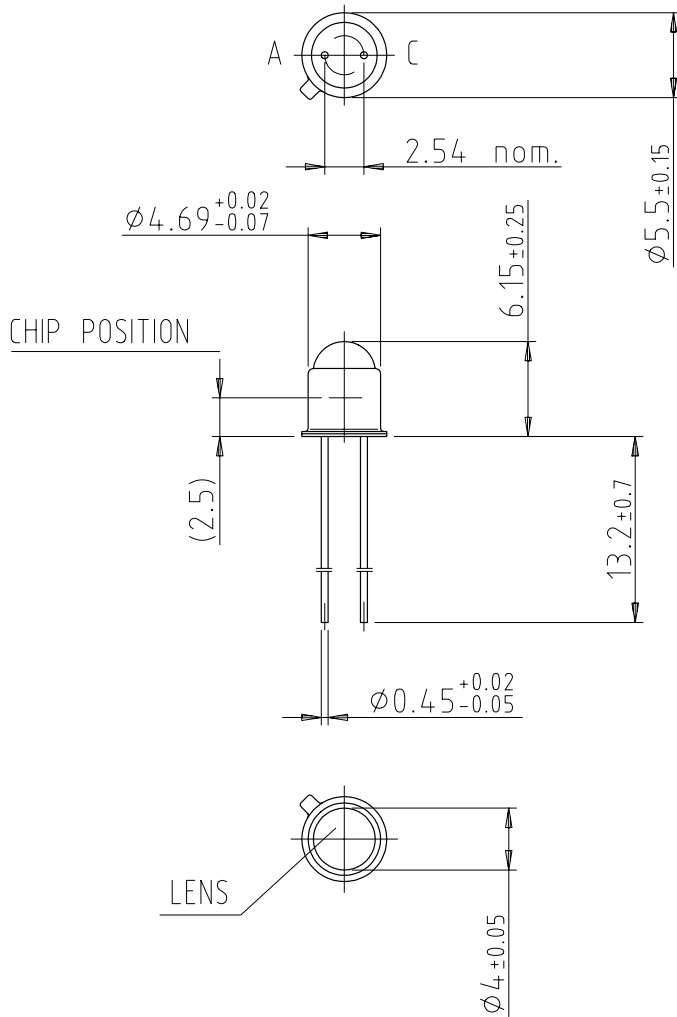

Figure 5. Diode Capacitance vs. Reverse Voltage

Dimensions in mm



14487

technical drawings
according to DIN
specifications



Ozone Depleting Substances Policy Statement

It is the policy of **Vishay Semiconductor GmbH** to

1. Meet all present and future national and international statutory requirements.
2. Regularly and continuously improve the performance of our products, processes, distribution and operating systems with respect to their impact on the health and safety of our employees and the public, as well as their impact on the environment.

It is particular concern to control or eliminate releases of those substances into the atmosphere which are known as ozone depleting substances (ODSs).

The Montreal Protocol (1987) and its London Amendments (1990) intend to severely restrict the use of ODSs and forbid their use within the next ten years. Various national and international initiatives are pressing for an earlier ban on these substances.

Vishay Semiconductor GmbH has been able to use its policy of continuous improvements to eliminate the use of ODSs listed in the following documents.

1. Annex A, B and list of transitional substances of the Montreal Protocol and the London Amendments respectively
2. Class I and II ozone depleting substances in the Clean Air Act Amendments of 1990 by the Environmental Protection Agency (EPA) in the USA
3. Council Decision 88/540/EEC and 91/690/EEC Annex A, B and C (transitional substances) respectively.

Vishay Semiconductor GmbH can certify that our semiconductors are not manufactured with ozone depleting substances and do not contain such substances.

We reserve the right to make changes to improve technical design and may do so without further notice.

Parameters can vary in different applications. All operating parameters must be validated for each customer application by the customer. Should the buyer use Vishay-Semiconductors products for any unintended or unauthorized application, the buyer shall indemnify Vishay-Semiconductors against all claims, costs, damages, and expenses, arising out of, directly or indirectly, any claim of personal damage, injury or death associated with such unintended or unauthorized use.

Vishay Semiconductor GmbH, P.O.B. 3535, D-74025 Heilbronn, Germany
Telephone: 49 (0)7131 67 2831, Fax number: 49 (0)7131 67 2423

This datasheet has been download from:

www.datasheetcatalog.com

Datasheets for electronics components.